

# **SE-17225**

---

***μ*PD17225**

***μ*PD17226**

***μ*PD17227**

***μ*PD17228**

[MEMO]

***SIMPLEHOST* is a trademark of NEC Corporation.**

**Windows is either a registered trademark or a trademark of Microsoft Corporation in the United States and/or other countries.**

**PC/AT is a trademark of International Business Machines Corporation.**

- **The information in this document is subject to change without notice. Before using this document, please confirm that this is the latest version.**
- No part of this document may be copied or reproduced in any form or by any means without the prior written consent of NEC Corporation. NEC Corporation assumes no responsibility for any errors which may appear in this document.
- NEC Corporation does not assume any liability for infringement of patents, copyrights or other intellectual property rights of third parties by or arising from use of a device described herein or any other liability arising from use of such device. No license, either express, implied or otherwise, is granted under any patents, copyrights or other intellectual property rights of NEC Corporation or of others.
- Descriptions of circuits, software, and other related information in this document are provided for illustrative purposes in semiconductor product operation and application examples. The incorporation of these circuits, software, and information in the design of the customer's equipment shall be done under the full responsibility of the customer. NEC Corporation assumes no responsibility for any losses incurred by the customer or third parties arising from the use of these circuits, software, and information.

# Regional Information

Some information contained in this document may vary from country to country. Before using any NEC product in your application, please contact the NEC office in your country to obtain a list of authorized representatives and distributors. They will verify:

- Device availability
- Ordering information
- Product release schedule
- Availability of related technical literature
- Development environment specifications (for example, specifications for third-party tools and components, host computers, power plugs, AC supply voltages, and so forth)
- Network requirements

In addition, trademarks, registered trademarks, export restrictions, and other legal issues may also vary from country to country.

**NEC Electronics Inc. (U.S.)**

Santa Clara, California  
Tel: 408-588-6000  
800-366-9782  
Fax: 408-588-6130  
800-729-9288

**NEC Electronics (Germany) GmbH**

Duesseldorf, Germany  
Tel: 0211-65 03 02  
Fax: 0211-65 03 490

**NEC Electronics (UK) Ltd.**

Milton Keynes, UK  
Tel: 01908-691-133  
Fax: 01908-670-290

**NEC Electronics Italiana s.r.l.**

Milano, Italy  
Tel: 02-66 75 41  
Fax: 02-66 75 42 99

**NEC Electronics (Germany) GmbH**

Benelux Office  
Eindhoven, The Netherlands  
Tel: 040-2445845  
Fax: 040-2444580

**NEC Electronics (France) S.A.**

Velizy-Villacoublay, France  
Tel: 01-30-67 58 00  
Fax: 01-30-67 58 99

**NEC Electronics (France) S.A.**

Madrid Office  
Madrid, Spain  
Tel: 91-504-2787  
Fax: 91-504-2860

**NEC Electronics (Germany) GmbH**

Scandinavia Office  
Taeby, Sweden  
Tel: 08-63 80 820  
Fax: 08-63 80 388

**NEC Electronics Hong Kong Ltd.**

Hong Kong  
Tel: 2886-9318  
Fax: 2886-9022/9044

**NEC Electronics Hong Kong Ltd.**

Seoul Branch  
Seoul, Korea  
Tel: 02-528-0303  
Fax: 02-528-4411

**NEC Electronics Singapore Pte. Ltd.**

United Square, Singapore  
Tel: 65-253-8311  
Fax: 65-250-3583

**NEC Electronics Taiwan Ltd.**

Taipei, Taiwan  
Tel: 02-2719-2377  
Fax: 02-2719-5951

**NEC do Brasil S.A.**

Electron Devices Division  
Guarulhos-SP Brasil  
Tel: 55-11-6462-6810  
Fax: 55-11-6462-6829

## CONTENTS

<b>CHAPTER 1 GENERAL .....</b>	<b>1</b>
<b>CHAPTER 2 SPECIFICATIONS.....</b>	<b>3</b>
<b>CHAPTER 3 BLOCK DIAGRAM .....</b>	<b>5</b>
<b>CHAPTER 4 USAGE .....</b>	<b>7</b>
<b>4.1 Setting SE Board to Support <math>\mu</math>PD17225 Subseries .....</b>	<b>7</b>
<b>4.2 Using Level Conversion Chip (<math>\mu</math>PD6706GF).....</b>	<b>9</b>
<b>4.3 Supplying Power to SE Board .....</b>	<b>10</b>
<b>4.4 Option Switch .....</b>	<b>16</b>
<b>4.5 Changing Oscillation Frequency .....</b>	<b>17</b>
<b>4.6 Use When SE Board Is Connected to In-Circuit Emulator .....</b>	<b>20</b>
4.6.1 Connection/disconnection to/from in-circuit emulator.....	20
4.6.2 Supplying power .....	21
4.6.3 Transferring ICE file to in-circuit emulator .....	22
4.6.4 If no response is returned from in-circuit emulator .....	23
4.6.5 Error messages and remedial actions .....	24
<b>4.7 Using SE Board Alone .....</b>	<b>26</b>
<b>4.8 Monitor Pin and LED.....</b>	<b>30</b>
<b>4.9 Setting of Jumper Switches and Slide Switches .....</b>	<b>32</b>
<b>CHAPTER 5 CONNECTOR PIN LIST .....</b>	<b>35</b>
<b>CHAPTER 6 DRAWING OF EMULATION PROBE AND CONVERSION ADAPTER .....</b>	<b>37</b>
6.1 Drawing of Emulation Probe (optional) .....	37
6.2 Drawing of Conversion Adapter (optional).....	40
<b>CHAPTER 7 NOTES ON USING EMULATION PROBE (EP-17K28GT) .....</b>	<b>41</b>

## LIST OF FIGURES

Figure No.	Title	Page
2-1	Component Layout of SE-17225 .....	4
3-1	Block Diagram of SE-17225 .....	5
4-1	Example of Mounting Real Chips .....	8
4-2	At $V_{DD} = +3\text{ V}$ , $V_{CC} = +5\text{ V}$ .....	13
4-3	Supplying $V_{DD}$ from CN12 Pin .....	13
4-4	Supplying $V_{DD}$ from Emulation Probe .....	14
4-5	At $V_{DD} = +3\text{ V}$ , $V_{CC} = +5\text{ V}$ .....	14
4-6	Supplying $V_{DD}$ from CN12 Pin .....	15
4-7	Supplying $V_{DD}$ from Emulation Probe .....	15
4-8	Option Switch .....	16
4-9	Initial Status of Component Block (PH1) .....	18
4-10	Peripheral Circuit of Component Block (PH1) .....	19
4-11	Appearance of IE-17K (with exterior lid opened) .....	20
4-12	Connection/Disconnection of SE-17225 .....	21
4-13	Setting of ROM/RAM Select Slide Switch .....	26
4-14	PROM (IC2) Mounting Socket .....	27
4-15	Setting of $\mu\text{PD27C512D}$ , $27\text{C1001D}$ , $27\text{C4001CZ}$ Select Slide Switch .....	28
4-16	Example of Connection When SE-17225 Alone Is Used .....	29
4-17	Monitor Pin and LED Locations .....	31
6-1	Drawing of EP-17K28CT (unit: mm) .....	37
6-2	Drawing of EP-17K28GT (cable) (unit: mm) .....	38
6-3	Drawing of EP-17K28GT (connector board) (unit: mm) .....	39
6-4	Drawing of Conversion Adapter (unit: mm) .....	40

## LIST OF TABLES

Table No.	Title	Page
1-1	Development Tools for SE-17225 .....	2
4-1	Product to Be Evaluated, Real Chip, and Memory Size Select Switch .....	7
4-2	Function of JS1 When SE Board Is Connected to In-Circuit Emulator .....	11
4-3	Function of JS1 When SE Board Alone Is Used .....	11
4-4	Power Supply Pins and Their Functions .....	12
4-5	Setting of Option Switch .....	16
4-6	Operating Frequency Changeable Range .....	17
4-7	Device Number and SE Board Number .....	24
4-8	Monitor Pins and Their Functions .....	30
4-9	Factory-Set Conditions of Jumper Switches and Slide Switches .....	33
5-1	Connector Pins of J1 .....	35

[MEMO]



## CHAPTER 1 GENERAL

The SE-17225 is a system evaluation board (SE board) for the  $\mu$ PD17225 Subseries of 4-bit single-chip microcontrollers.

The SE-17225 is attached to an in-circuit emulator (IE-17K or IE-17K-ET) that can be commonly used with any model in the 17K Series for debugging, or used alone for system evaluation.

Because the real chip,  $\mu$ PD17225GT-00X, 17226GT-00X, 17227GT-00X, or 17228GT-00X (hereafter referred to as the "real chip"), is used to interface with the target system<sup>Note 1</sup>, the functions of the SE-17225 are equivalent to those of the product to be evaluated.

To connect the SE-17225 and the target system, emulation probes (EP-17K28CT<sup>Note 2</sup> or EP-17K28GT<sup>Note 3</sup> +EV-9500GT-28 (optional)) is necessary.

**Notes** 1. The user-created system to be evaluated.

2. For 28-pin plastic shrink DIP (400 mil)

3. For 28-pin plastic SOP (375 mil)

Table 1-1. Development Tools for SE-17225

SE Board	Usage	Output File of Assembler (host machine)	In-circuit Emulator	Support Software <sup>Note 3</sup>	Emulation Probe	Product to Be Evaluated
SE-17225	When used with in-circuit emulator	ICE file <sup>Note 1</sup> (PC-9800 Series IBM PC/AT™)	IE-17K IE-17K-ET	<i>SIMPLEHOST</i> ™	EP-17K28CT EP-17K28GT +	μPD17225 μPD17226 μPD17227
	When SE-17225 alone is used	PRO file <sup>Note 2</sup> (PC-9800 Series IBM PC/AT)	Unnecessary	Unnecessary	EV-9500GT-28 (conversion adapter)	μPD17228

**Notes 1.** ICE file : Automatically output after the source program is assembled

**2.** PRO file: Output if an assembler option (/PRO) is specified when the source program is assembled.  
For the details of the ICE file and PRO file, refer to the User's Manual of the AS17K or RA17K.

**3.** *SIMPLEHOST* is software for man-machine interfacing with the in-circuit emulator.

This software runs on Windows™ and can debug source lists and figures displayed on CRT through mouse operation.

For details, refer to the User's Manual of *SIMPLEHOST*.

Interfacing can be executed with a commercially available RS-232C communication software other than *SIMPLEHOST*, but in this case knowledge on how to set the baud rate and how to use the commands of the in-circuit emulator is necessary.

For details, refer to the User's Manual of the IE-17K or IE-17K-ET.

## CHAPTER 2 SPECIFICATIONS

This chapter explains the specifications of the SE-17225.

Product name	: SE-17225
Program memory	: • When used with an in-circuit emulator (IE-17K or IE-17K-ET), the $\mu$ PD43256BGU ( $\mu$ PD431000AGW) mounted on the board is used. • When the SE-17225 is used alone, write the program to the $\mu$ PD27C512D, 27C1001D, or $\mu$ PD27C4001CZ, and attach the ROM to the socket (IC2) on the SE-17225.
Data memory	: The internal memory of the real chip is used.
Operating frequency	: 1 to 8 MHz (4 MHz as a factory-set condition for shipment)
Instruction cycle	: 4 $\mu$ s (high-speed mode) or 8 $\mu$ s (normal mode): When operated at 4 MHz
Operating temperature	: +10 to +40°C
Storage temperature	: -10 to +50°C (without condensation)
Supply voltage	: • Supply voltage for real chip ( $V_{DD}$ ): 2.7 to 3.6 V The voltage is supplied from the emulation probe or CN12. • Supply voltage for SE-17225 ( $V_{CC}$ ): +5 V $\pm$ 5% When the SE-17225 is used with an in-circuit emulator, the voltage is supplied from the in-circuit emulator. When the SE-17225 is used alone, supply the voltage from the CN11 pin.
Current consumption	: 140 mA (MAX.), (no load, with 1M of program memory used)
Dimensions	: 150 $\times$ 174 $\times$ 37 mm

Figure 2-1. Component Layout of SE-17225

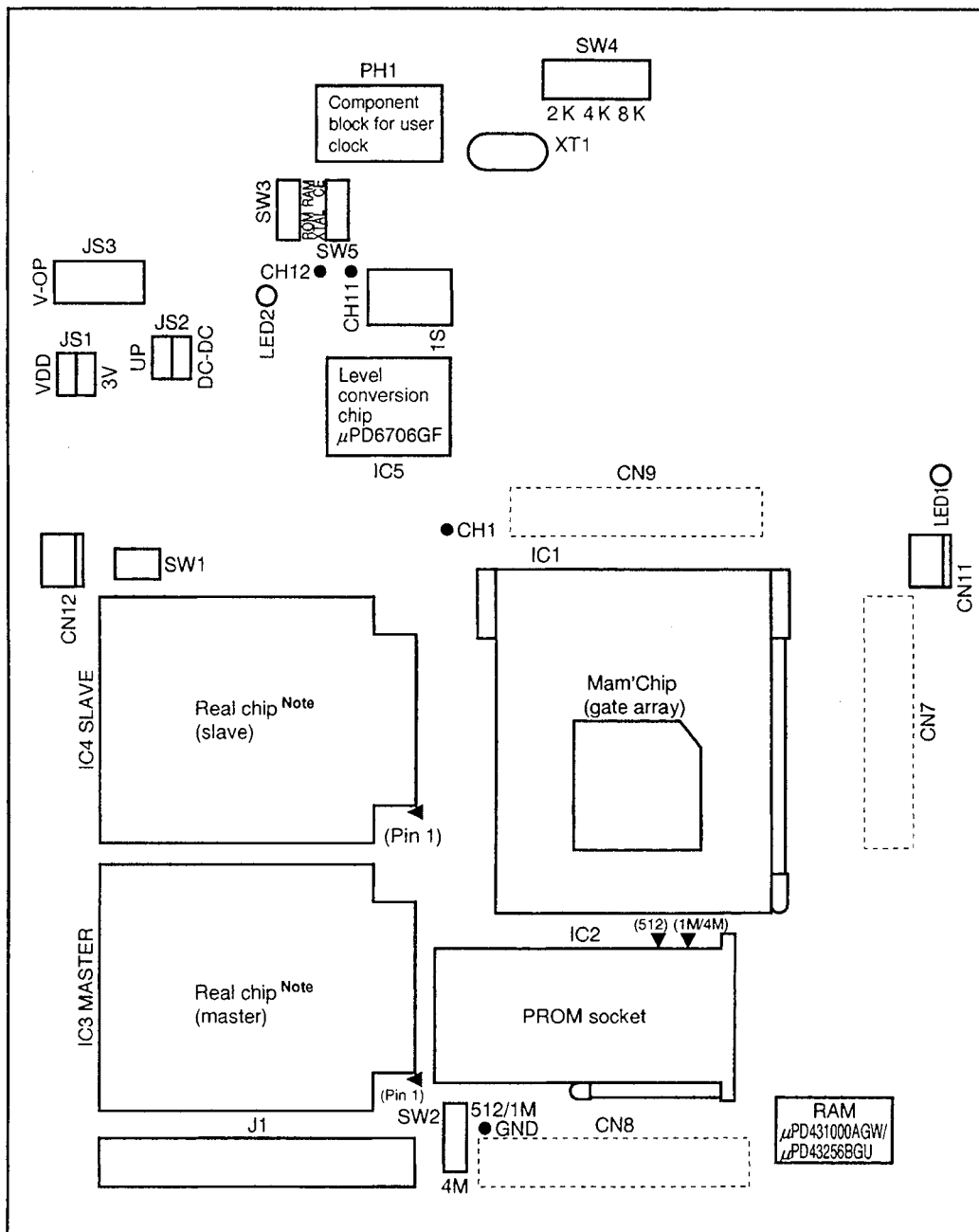

**Remark** The components shown within broken lines are mounted on the rear side.

**Note** Mount the  $\mu$ PD17225GT-00x to evaluate the  $\mu$ PD17225.  
 Mount the  $\mu$ PD17226GT-00x to evaluate the  $\mu$ PD17226.  
 Mount the  $\mu$ PD17227GT-00x to evaluate the  $\mu$ PD17227.  
 Mount the  $\mu$ PD17228GT-00x to evaluate the  $\mu$ PD17228.  
 The  $\mu$ PD17228GT-00x is mounted at factory shipping.



[MEMO]

## CHAPTER 4 USAGE

### 4.1 Setting SE Board to Support $\mu$ PD17225 Subseries



When evaluating each product by using the SE-17225, real chips corresponding to the product to be evaluated must be attached to the sockets IC3 (MASTER) and IC4 (SLAVE) on the SE board.

The SE-17225 is factory-set to evaluate the  $\mu$ PD17228 for shipment, and the  $\mu$ PD17228GT-00X is attached to IC3 and IC4. To evaluate a model other than the  $\mu$ PD17228, therefore, the real chips must be replaced.

In this case, the setting of the memory size select switch (SW4) must be also changed.

Table 4-1 shows how to set this switch when evaluating products in the  $\mu$ PD17225 Subseries.

**Table 4-1. Product to Be Evaluated, Real Chip, and Memory Size Select Switch**

Setting Target Device	Real Chips Mounted to IC3 and IC4	Setting of Memory Size Select Switch
$\mu$ PD17225	$\mu$ PD17225GT-00x	SW4  2 K 4 K 8 K (225) (226) (227, 228)
$\mu$ PD17226	$\mu$ PD17226GT-00x	SW4  2 K 4 K 8 K (225) (226) (227, 228)
$\mu$ PD17227	$\mu$ PD17227GT-00x	SW4  2 K 4 K 8 K (225) (226) (227, 228)
$\mu$ PD17228	$\mu$ PD17228GT-00x	

**Remark** The shaded portion indicates the selected switch position.

Figure 4-1. Example of Mounting Real Chips

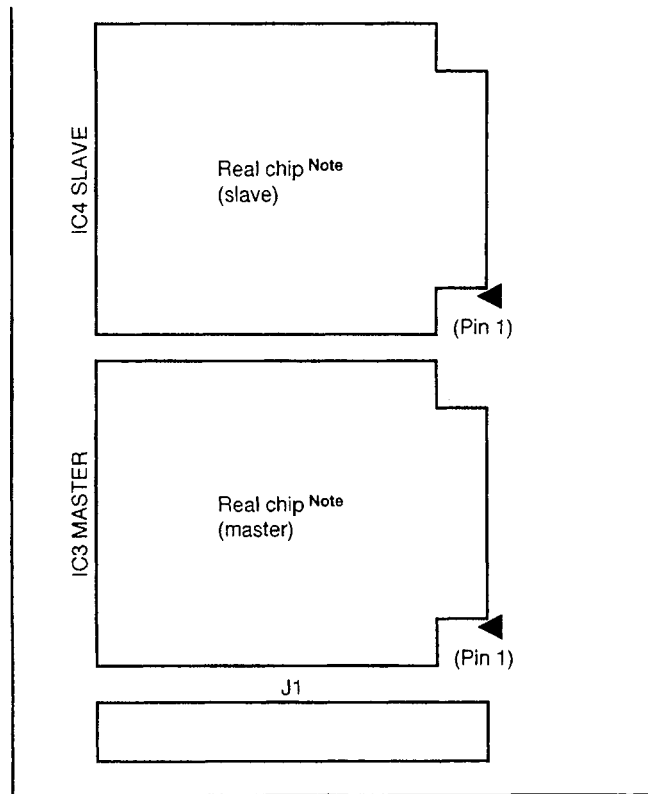

**Note** Use the following models as the real chips:

$\mu$ PD17225GT-00X

$\mu$ PD17226GT-00X

$\mu$ PD17227GT-00X

$\mu$ PD17228GT-00X

**Caution** To replace the real chips, insert the new chips to the sockets on the SE board with the power turned OFF. Match the direction of pin 1 of the chip with the indication on the board.



## 4.2 Using Level Conversion Chip ( $\mu$ PD6706GF)

### (1) Outline of level conversion chip

The level conversion chip is an IC that converts between the levels of two types of voltages if the operating voltage of the target board and that of the SE board are different ( $V_{DD} \neq V_{CC}$ ,  $V_{CC} = +5V$ ). Therefore, even if the operating voltages of the target system and SE board are different, signals can be smoothly transferred between the two.

### (2) Using level conversion chip

The level conversion chip automatically starts operating when a voltage of 5 V or higher is applied between the  $V_{DD}$  or CN12 pin and GND pin of the emulation probe with the power supply mode select jumper switch (JS1) of the SE board set to the  $V_{DD}$  side.

**Remarks 1.**  $V_{DD}$  is the supply voltage to the target system. Power can be supplied from the target system to the real chip on the SE board from the CN12 pin or emulation probe. Therefore, debugging can be executed in an environment close to the real environment.

**2.**  $V_{CC}$  is the supply voltage to operate the SE board (except the real chip), and is always +5 V. When the SE-17225 is connected to an in-circuit emulator, this voltage is automatically supplied from the in-circuit emulator. When the SE board is used alone, supply  $V_{CC}$  from the CN11 pin.

### 4.3 Supplying Power to SE Board

Two voltages must be supplied to the SE board. One is  $V_{CC}$  to operate the SE board (except the real chip), and the other is  $V_{DD}$  to operate the real chip.

$V_{CC}$  must always be +5 V, and  $V_{DD}$  must be a voltage in the operating voltage range of the real chip (2.7 to 3.6 V).

(1) Jumper switch selecting mode of power supply to SE board (JS1)

Jumper switch JS1 selects whether a voltage is supplied to the real chip from the power supplied to the SE board ( $V_{CC} = +5$  V) (in this case, the +5 V is converted to +3 V), or from the power supplied from the emulation probe or CN12 pin ( $V_{DD}$ ).

Tables 4-2 and 4-3 show the function of JS1 when the SE board is connected to an in-circuit emulator and when the SE board is used alone.

If the supply voltage of the target system is +3 V, set JS1 to the +3 V side. When the SE board is connected to an in-circuit emulator, +3 V is automatically supplied from the in-circuit emulator. When the SE board alone is used, +5 V supplied from the CN11 pin is converted to +3 V; therefore, power can be supplied very easily.

If the supply voltage of the target system is not +3 V, set JS1 to the  $V_{DD}$  side to supply the voltage of the target system to the real chip from the emulation probe or CN12 pin; this enables evaluation in an environment close to the real environment.

**Table 4-2. Function of JS1 When SE Board Is Connected to In-Circuit Emulator**

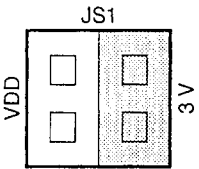
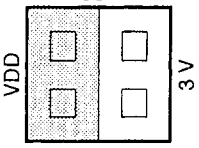
Setting of JS1	Type of Power	Power Supplied to Real Chip ( $V_{DD}$ )	Power to Operate SE Board (except real chip) ( $V_{CC}$ )
 <p>The diagram shows a switch labeled JS1 with two columns of two switches each. The right column is shaded, indicating it is selected.</p>		+5 V from in-circuit emulator is converted to +3 V and supplied.	+5 V is supplied from in-circuit emulator.
 <p>The diagram shows a switch labeled JS1 with two columns of two switches each. The left column is shaded, indicating it is selected.</p>		Power must be supplied from emulation probe or CN12 pin.	

**Table 4-3. Function of JS1 When SE Board Alone Is Used**

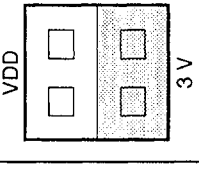
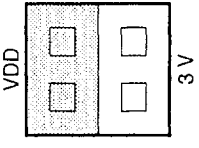
Setting of JS1	Type of Power	Power Supplied to Real Chip ( $V_{DD}$ )	Power to Operate SE Board (except real chip) ( $V_{CC}$ )
 <p>The diagram shows a switch labeled JS1 with two columns of two switches each. The right column is shaded, indicating it is selected.</p>		+5 V from in-circuit emulator is converted to +3 V and supplied.	+5 V is supplied from CN11 pin.
 <p>The diagram shows a switch labeled JS1 with two columns of two switches each. The left column is shaded, indicating it is selected.</p>		Power must be supplied from emulation probe or CN12 pin.	

The shaded portion indicates the selected switch position.

**(2) Power supply pins**

This SE board has three pins from which power is supplied from external sources. These pins must be appropriately used depending on the evaluation environment. Table 4-4 lists these pins and their functions.

**Table 4-4. Power Supply Pins and Their Functions**

Pin Name	Type of Power (range of power that can be supplied)	Function
CN11	V <sub>CC</sub> (+5 V ±5%)	Operating power supply pin used when the SE board alone is used (except real chip). Always supply +5 V to this pin. When the SE board is connected to an in-circuit emulator, do not supply power from the CN11 pin.
CN12	V <sub>DD</sub> (2.7 to 3.6 V)	Pin supplying operating voltage to real chip if power of target system is V <sub>DD</sub> ≠ +3 V (JS1 is set to V <sub>DD</sub> side).
Emulation probe (V <sub>DD</sub> and GND pins)	V <sub>DD</sub> (2.7 to 3.6 V)	The function is equivalent to that of the CN12 pin. The CN12 pin and power supply pin of the emulation probe are connected on the SE board. Supply power either from the CN12 pin or emulation probe, or supply the same voltage from both.

**Remark** Pin 1 of the CN11 and CN12 pins is GND, and pin 2 is the power supply. Use the power cable attached as an accessory to supply power.

(3) Example of actual use

<1> When SE board is connected to in-circuit emulator

(a) When SE board is connected to in-circuit emulator at  $V_{DD} = +3\text{ V}$ ,  $V_{CC} = +5\text{ V}$

Set JS1 to the 3 V side.  $V_{CC}$  and  $V_{DD}$  are supplied from the in-circuit emulator. No power has to be supplied from the CN11 and CN12 pins or from the emulation probe.

Figure 4-2. At  $V_{DD} = +3\text{ V}$ ,  $V_{CC} = +5\text{ V}$

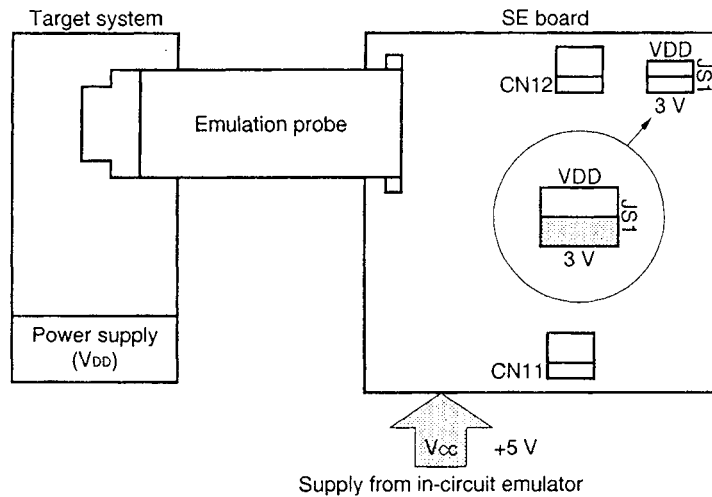

(b) When the SE board is connected to in-circuit emulator at  $V_{DD} \neq +3\text{ V}$ ,  $V_{CC} = +5\text{ V}$

Set JS1 to the  $V_{DD}$  side. Supply  $V_{CC}$  from the in-circuit emulator, and  $V_{DD}$  from the CN12 pin or emulation probe.

Figure 4-3. Supplying  $V_{DD}$  from CN12 Pin

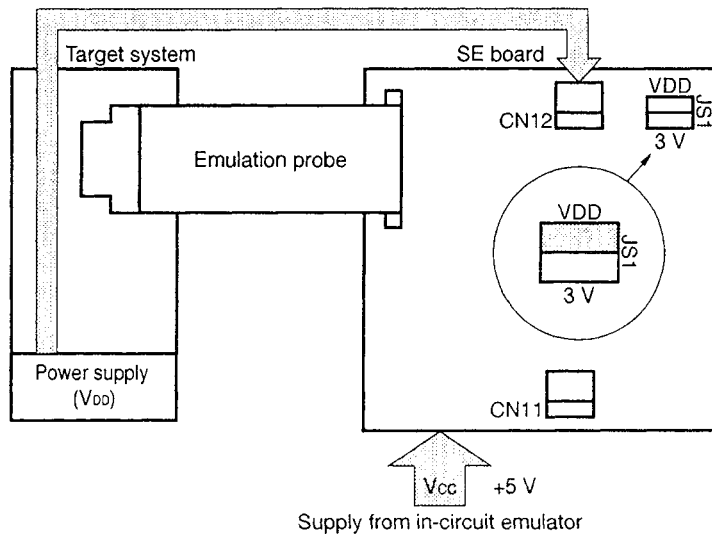
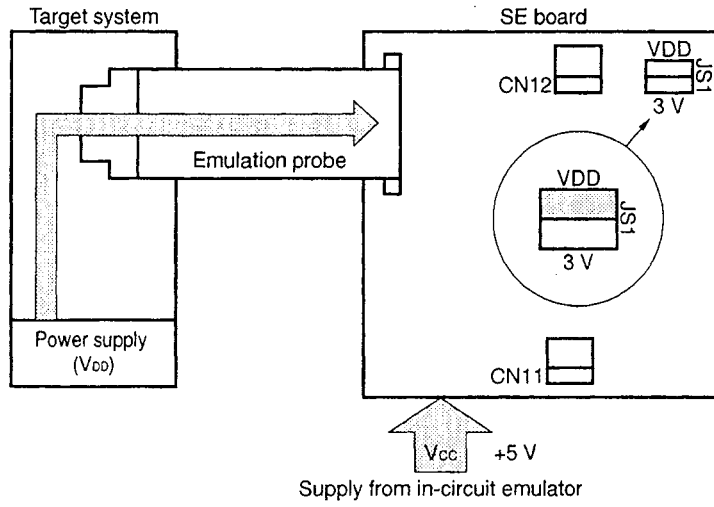

Figure 4-4. Supplying  $V_{DD}$  from Emulation Probe



<2> When SE board alone is used

(a) When SE board is used alone at  $V_{DD} = +3\text{ V}$ ,  $V_{CC} = +5\text{ V}$

Set JS1 to the 3 V side. Supply  $V_{CC}$  and  $V_{DD}$  from the CN11 pin.

Figure 4-5. At  $V_{DD} = +3\text{ V}$ ,  $V_{CC} = +5\text{ V}$

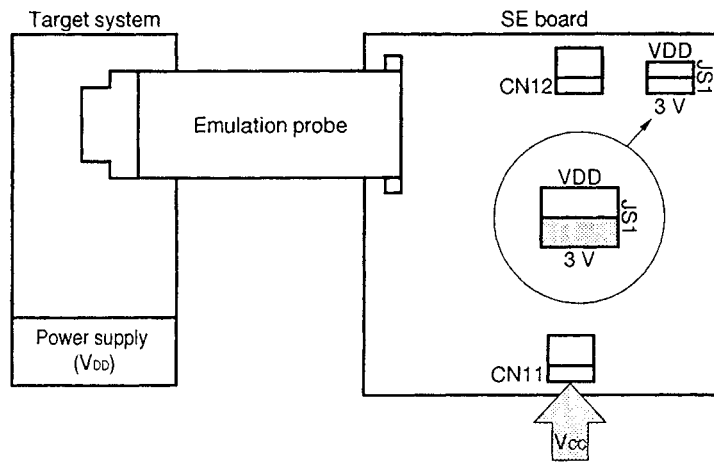

(b) When SE board alone is used at  $V_{DD} \neq +3\text{ V}$ ,  $V_{CC} = +5\text{ V}$

Set JS1 to the  $V_{DD}$  side. Supply  $V_{CC}$  from the CN11 pin, and  $V_{DD}$  from the CN12 pin or emulation probe.

Figure 4-6. Supplying  $V_{DD}$  from CN12 Pin

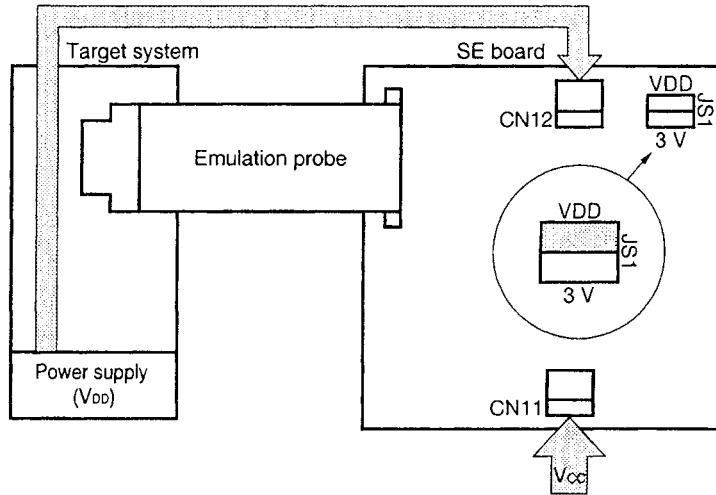
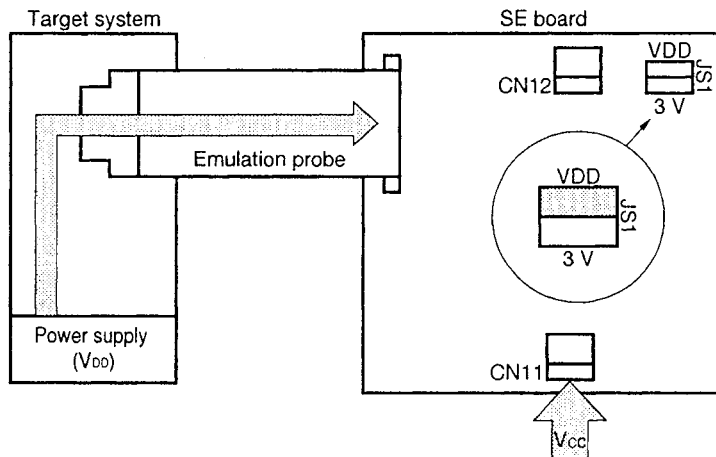

Figure 4-7. Supplying  $V_{DD}$  from Emulation Probe



### 4.4 Option Switch

A mask option can be set for the  $\overline{\text{RESET}}$  pin of the  $\mu\text{PD17225}$  Series.

In the debugging environment of the SE-17225, an option switch (1S) is provided to reproduce a dummy mask option switch described in the source program.

Figure 4-8. Option Switch

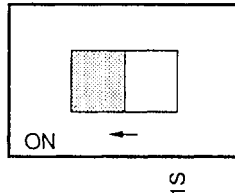

The shaded portion indicates the factory setting.

Table 4-5. Setting of Option Switch

Switch No.	Pin Name	ON	OFF	Switch Code
1S	$\overline{\text{RESET}}$	Pulled up	Not pulled up	0000

If the mask option information described in the source program does not match the setting of the option switch on the SE board, the in-circuit emulator outputs the following warning message:

```
? IOS INVALID OPTION SWITCH AT xxxx
xxxx : switch code
```

The switch code indicates the position of the option switch that has been erroneously set on the SE board.

The assembler in the 17K Series describes specification of a mask option in the source program. The in-circuit emulator checks whether the setting of the option switch on the SE board matches the setting specified by the program immediately after the ICE file has been loaded by using the ".LPO" or ".LP1" command. If the above message is output, check the setting of the option switch.

- Cautions**
1. When connecting the SE board to an in-circuit emulator, if the emulation probe is not used to connect the SE board to the target board, and if the SE board is used with option switch 1S ( $\overline{\text{RESET}}$ ) turned OFF, the reset function of the SE board may be undefined and the SE board may malfunction.
  2. The SE-17225 cannot set the low-voltage detection circuit (POC) of the mask option of the real chip. Therefore, the in-circuit emulator outputs the following warning message when the source program is loaded. Thoroughly check the mask option of the low-voltage detection circuit by the source program.

```
[Warning message]
SOME MASK-OPTIONS COULD NOT BE CHECKED BY CLICE.
```



### 4.5 Changing Oscillation Frequency

The operating frequency of the SE-17225 can be changed from the factory-set value.

**Table 4-6. Operating Frequency Changeable Range**

Device Mounted to IC3 and IC4	Factory-Set Condition	Operating Frequency Range	Changing Method
$\mu$ PD17225GT-00× $\mu$ PD17226GT-00×	4 MHz (ceramic oscillation)	1 MHz to 8 MHz	Configure oscillation circuit on component block (PH1)
$\mu$ PD17227GT-00× $\mu$ PD17228GT-00×	4 MHz (crystal oscillation)	Fixed to 4 MHz	Adjustable with trimmer capacitor on SE board (C19)

**Remark** Setting of clock oscillator select switch

**<1> To use 4-MHz crystal resonator (XT1) clock**

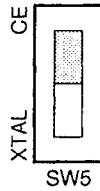

**<2> To use clock from oscillator attached to PH1**

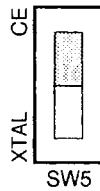

**(1) To use crystal resonator**

When the clock oscillator select switch (SW5) is set to the "XTAL" side, 4 MHz (fixed XT1) is supplied to the real chip from the crystal resonator as the oscillation frequency. To fine-tune the oscillation frequency, use the trimmer capacitor (C19) on the SE board.

The output waveform of the oscillation frequency is output to monitor pin CH11. To change the oscillation frequency, adjust C19 by monitoring the wave output to CH11 on an oscilloscope.

**Caution** Because this clock is also used for emulation, fix it to 4 MHz (do not disconnect the resonator).

**(2) To use ceramic oscillator (to change frequency)**

When the clock oscillator select switch (SW5) is set to the "CE" side, the clock is supplied from the oscillation circuit configured on the component block (PH1). Adjust the oscillation frequency by using the trimmer capacitor on PH1.

An oscillator can be connected to any of the pins 1 to 14 of PH1. As a factory-set condition for shipment, a 4-MHz ceramic oscillator is attached to PH1. In addition, a trimmer capacitor adjusted to 30 pF is connected between pins 5 and 10, and a 33-pF capacitor is connected between pins 7 and 8. A 1-M $\Omega$  resistor is connected between pins 3 and 12, taking in consideration the internal feedback resistance of the microcontroller.

The output wave of the oscillation frequency is also output to monitor pin CH12. When changing the oscillation frequency, therefore, adjust the trimmer capacitor on PH1 while monitoring the wave output to CH12.

**Figure 4-9. Initial Status of Component Block (PH1)**

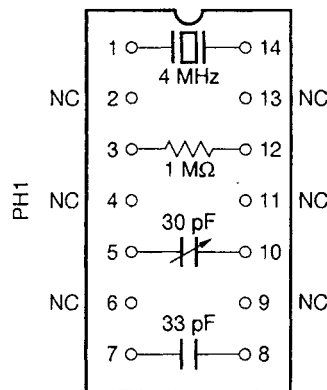
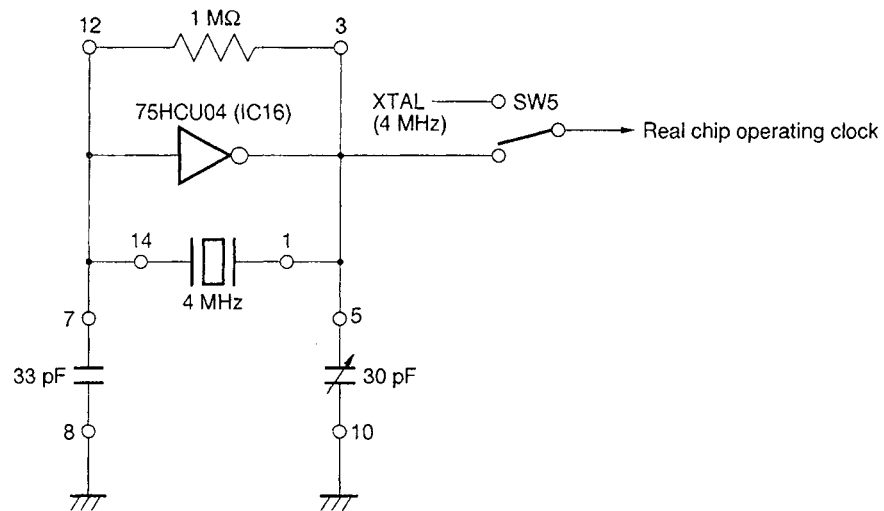

Figure 4-10. Peripheral Circuit of Component Block (PH1)



- Remarks 1.** To change the oscillation frequency, connect a crystal or ceramic oscillator of the desired frequency between pins 1 and 4. At this time, also exchange components such as the capacitor if necessary.
- 2.** To change the oscillator stabilizer (capacitor), exchange the capacitors between pins 5 and 10, and between pins 7 and 8.

## 4.6 Use When SE Board Is Connected to In-Circuit Emulator

An in-circuit emulator is connected to a host machine such as the PC-9800 Series, and is used to debug the target system. For the details of the operations, refer to the User's Manual of the IE-17K or IE-17K-ET.

### 4.6.1 Connection/disconnection to/from in-circuit emulator

Connect the SE-17225 to the in-circuit emulator as follows:

- <1> Open the exterior lid and interior lid of the in-circuit emulator.
- ☞ When the interior lid has been opened, a memory board is visible. Connect the three connectors on the bottom of the SE-17225 (CN7, CN8, and CN9) to the mating connectors on the memory board.

To remove the SE-17225 from the in-circuit emulator, lift the SE board at right angles.

Figure 4-11. Appearance of IE-17K (with exterior lid opened)

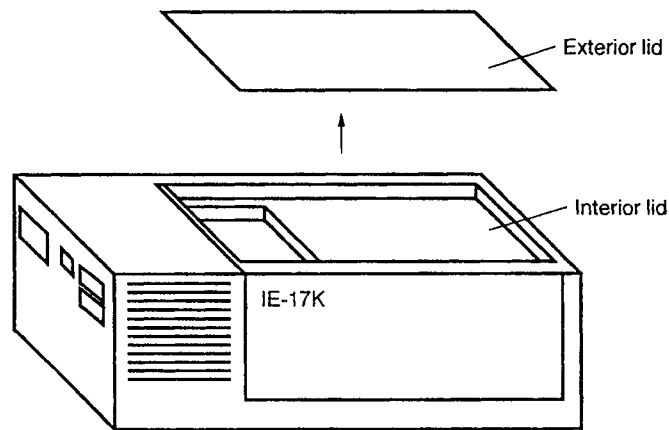
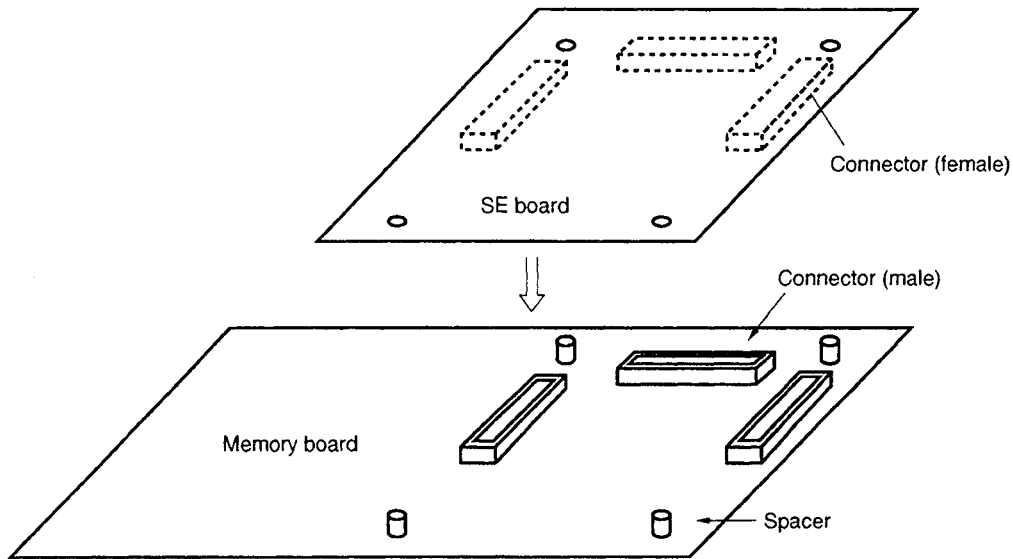

Figure 4-12. Connection/Disconnection of SE-17225



Next, connect the emulation probe to the connector J1 of the SE-17225 to connect the target system. Then attach the interior lid and exterior lid.

#### 4.6.2 Supplying power

After connecting the SE-17225 to the in-circuit emulator and before attaching the interior and exterior lids to the emulator, supply power to the in-circuit emulator to see if LED1 on the SE-17225 lights.

If the supply voltage of the target system is not +3 V, the supply voltage of the target system can be applied to the real chip on the SE board from the CN12 pin or emulation probe. For details, refer to **4.2 Using Level Conversion Chip ( $\mu$ PD6706GF)** and **4.3 Supplying Power to SE Board**.

If LED1 remains unlit, possible causes are:

- The power cable of the in-circuit emulator is not connected.
- An overcurrent (about 500 mA or higher) flows to the SE-17225.
- The SE-17225 is not correctly connected to the in-circuit emulator.

If LED1 does not light, turn off power to the in-circuit emulator, and correctly connect the SE-17225. If LED1 still remains unlit, the SE-17225 may be faulty.

- Cautions**
1. Turn on the power to the in-circuit emulator first, and then the power to the target system.
  2. Do not use the reset switch (SW1) on the SE board.  
To reset the in-circuit emulator, use the reset switch on the in-circuit emulator.

### 4.6.3 Transferring ICE file to in-circuit emulator

The in-circuit emulator (IE-17K or IE-17K-ET) is connected to a host machine such as the PC-9800 Series and used to debug the software and hardware of the target system. For details, refer to the User's Manual of the IE-17K or IE-17K-ET.

When using the *SIMPLEHOST*, also refer to the User's Manual of *SIMPLEHOST*.

Next, the procedure to check whether the SE-17225 is correctly connected to the in-circuit emulator when using a commercially available RS-232C communication software is explained.

When using *SIMPLEHOST*, the screen "LISTING" is displayed to indicate the correct connection.

- <1> Turn on power to the in-circuit emulator. If the power has been already turned on, press the reset switch to restart the in-circuit emulator. A prompt (@@@>) will be displayed.
- <2> Next, load the ICE file of the program developed in assembler, or the ICE file output by the .SP0 or .SP1 command, by using the .LP0 or .LP1 command.

The in-circuit emulator will not operate until this ICE file has been loaded.

If the SE board is correctly connected to the in-circuit emulator, a prompt (BRK>) will be displayed as shown below.

**Example** When ICE file for  $\mu$ PD17226 has been loaded

```
OK
D17226
BRK>
```

If the above message is not displayed, possible causes are:

- The real chip on the SE-17225 does not correspond to the loaded ICE file.
- An SE board other than the SE-17225 is connected to the in-circuit emulator.
- An ICE file other than that for the  $\mu$ PD17225 Subseries has been loaded.
- The setting of the option switch is different from the description of the program.
- The SE-17225 is not properly connected to the in-circuit emulator.

#### 4.6.4 If no response is returned from in-circuit emulator

If the in-circuit emulator does not respond, take the following remedial actions:

- <1> The SE board and the in-circuit emulator may not be properly connected. Check the connection of the SE board.
- <2> The target system and SE board may not be correctly connected with the emulation board. Check the connections.
- <3> If JS1 is set to the  $V_{DD}$  side, power may not be supplied from the emulation probe or CN12 pin to the real chip. Either supply power from the emulation probe or CN12 pin, or set JS1 to the 3 V side.  
If JS1 is set to the 3 V side, +3 V is automatically supplied from the in-circuit emulator (refer to **4.3 Supplying Power to SE Board**).
- <4> The reset circuit of the target system may not operate correctly. In this case, the reset status of the SE board is undefined, and therefore, the in-circuit emulator cannot return a response.  
To check if this is the case, turn ON the mask option switch (1S:  $\overline{\text{RESET}}$ ) to restart the in-circuit emulator. At this time, a warning message (? IOS INVALID OPTION SWITCH AT XXXX) may be output, but the ICE file can be loaded. If the above is the case, immediately correct the target system or source program so that no error message is output.
- <5> Check the baud rate of the in-circuit emulator and that of the host machine. For how to set the baud rate of the in-circuit emulator, refer to the User's Manual of the IE-17K or IE-17K-ET.
- <6> Check to see if the setting of the memory size select switch matches the real chip on the SE board (refer to **Table 4-1. Components to Be Evaluated, Real Chip, and Memory Size Select Switch**).

#### 4.6.5 Error messages and remedial actions

An error message is displayed if the combination of the real chip on the in-circuit emulator, that on the SE board, and the loaded ICE file is wrong.

So that debugging can be accurately executed, an SE board number is registered to the SE-17225, and a device number is registered to the real chip.

Error messages that may be displayed and the remedial actions to be taken are explained below.

**Table 4-7. Device Number and SE Board Number**

Evaluation Device	Device Number	SE Board Number
$\mu$ PD17225	60	60
$\mu$ PD17226	61	
$\mu$ PD17227	62	
$\mu$ PD17228	63	

**Remarks 1.** A device number is the registration number of each chip.

**2.** The SE board number is the registration number of the SE board.

**3.** The device number and SE board number are included in the data in the loaded ICE file, and are used to check the development environments of the in-circuit emulator when the ICE file is loaded.

#### (1) Error message and remedial action if real chip on SE-17225 does not correspond to loaded ICE file

##### [Error message]

? IDI INVALID DEVICE ID NUMBER [xx-△△]

**Remark** xx indicates the device number of the real chip on the SE board, and △△ indicates the device number included in the loaded ICE file.

If this message is output, check whether the real chip on the SE board is correct. If a wrong chip is mounted on the SE board, turn OFF the power to the in-circuit emulator, replace the chip, and then load the ICE file again. If a wrong device file has been selected during assembly, reassemble the source file by using the correct device file, and load the source file again.



**(2) Error message and remedial action if SE board other than SE-17225 is connected**

**[Error message]**

? ISE INVALID SE BOARD NUMBER [□□-▽▽]

**Remark** □□ indicates the SE board number of the SE board actually connected, and ▽▽ indicates the SE board number included in the loaded ICE file.

If this message is output, check the SE board and loaded ICE file again.

**(3) Warning message and remedial action if mask option information described in source program does not match setting of option switch on SE board**

**[Warning message]**

? IOS INVALID OPTION SWITCH AT xxxx

**Remark** xxxx indicates a switch code indicating the position of the option switch on the SE board that has been incorrectly set.

For the remedial action in case this message is output, refer to **4.4 Option Switch**.

**Caution** If the program cannot be correctly read or modified, check again to see if the setting of the memory size select switch matches the mounted real chip.

## 4.7 Using SE Board Alone

### (1) Setting of ROM/RAM select slide switch

Set the ROM/RAM select slide switch (SW3) to the ROM side as shown in Figure 4-13.

Figure 4-13. Setting of ROM/RAM Select Slide Switch

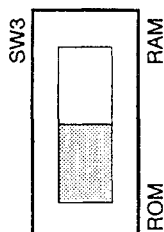

The shaded portion indicates the selected switch position.

### (2) Mounting PROM

When using the SE-17225 alone, attach PROM ( $\mu$ PD27C512D,  $\mu$ PD27C1001D, or  $\mu$ PD27C4001CZ) as the program memory.

Use a PROM that satisfies the following condition:

- ROM size
  - 512 Kbits :  $\mu$ PD27C512D-12, -15, -20, or equivalent
  - 1 Mbits :  $\mu$ PD27C1001D-12, -15, 20, or equivalent
  - 4 Mbits :  $\mu$ PD27C4001CZ-15 or equivalent

Either of the following output files must be written to the PROM as a program.

- PROM file for  $\mu$ PD17225 Subseries output by 17K Series assembler (.PRO)
- File output for PROM by command of in-circuit emulator (.XS0 or .XS1)

**Cautions 1. Do not write the ICE file (.ICE) output by the assembler to the in-circuit emulator. When the SE-17225 is used alone, it does not operate with the ICE file.**

2. The last address ( $\times 16$  bits) of the program memory for the  $\mu$ PD17225 Subseries is as follows:

$\mu$ PD17225	07FFH
$\mu$ PD17226	0FFFH
$\mu$ PD17227	17FFH
$\mu$ PD17228	1FFFH

Mount the PROM to the socket (IC2) on the SE board. Note that the mounting position differs depending on the number of pins of the PROM.

**Notes on mounting PROM**

- When using the  $\mu$ PD27C512D (28 pins), match the position of pin 1 with the inscription “▼512” on the side of the socket.
- When using the  $\mu$ PD27C1001D or 27C4001CZ (32 pins), match the position of pin 1 with the inscription “▼1M/4M” on the side of the socket.

Figure 4-14. PROM (IC2) Mounting Socket

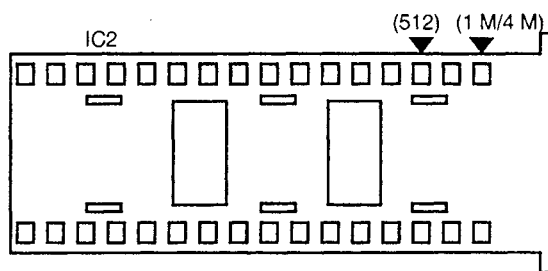
**(3) Setting of memory size select switch**

Set the memory size select switch as shown in Table 4-1, according to the product to be evaluated.

**(4) Setting of  $\mu$ PD27C512D, 27C1001D, 27C4001CZ select slide switch**

Set the slide switch (SW2) as shown in Figure 4-15, depending on which of the  $\mu$ PD27C512D,  $\mu$ PD27C1001D, or 27C4001CZ is used.

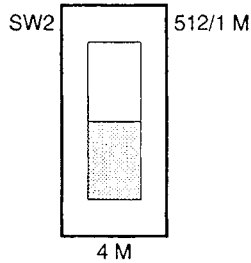
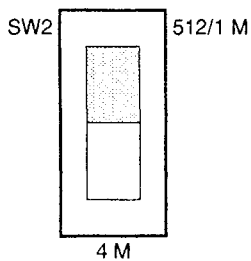
Figure 4-15. Setting of  $\mu$ PD27C512D, 27C1001D, 27C4001CZ Select Slide Switch(a) To use  $\mu$ PD27C4001CZ(b) To use  $\mu$ PD27C512D, 27C1001D

The shaded portion indicates the selected switch position.

**(5) Supplying power**

Be sure to supply  $5\text{ V} \pm 5\%$  ( $V_{CC}$ ) to the CN11 pin of the SE-17225 from an external power source.

If the supply voltage of the target system is not +3 V, the supply voltage of the target system can be applied to the real chip on the SE board from the CN12 pin or emulation probe. For details, refer to **4.2 Level Conversion Chip ( $\mu$ PD6706GF)** and **4.3 Supplying Power to SE Board**.

If  $V_{CC}$  is correctly supplied, LED1 on the SE-17225 lights.

If LED1 remains unlit, possible causes are:

- The power is not supplied to the SE board.
- An overcurrent flows (about 500 mA or higher).

**(6) Executing program**

Connect the SE-17225 and target system as shown in Figure 4-16. When the power to the target system is turned on, power is supplied to the SE-17225, power-ON reset is effected, and the program written to PROM is executed starting from address 0H.

The SE board can also be by pressing the reset switch on the SE-17225 forcibly reset. As a result, the program written to PROM is executed starting from address 0H, in the same manner as power-ON reset.

**Figure 4-16. Example of Connection When SE-17225 Alone Is Used**

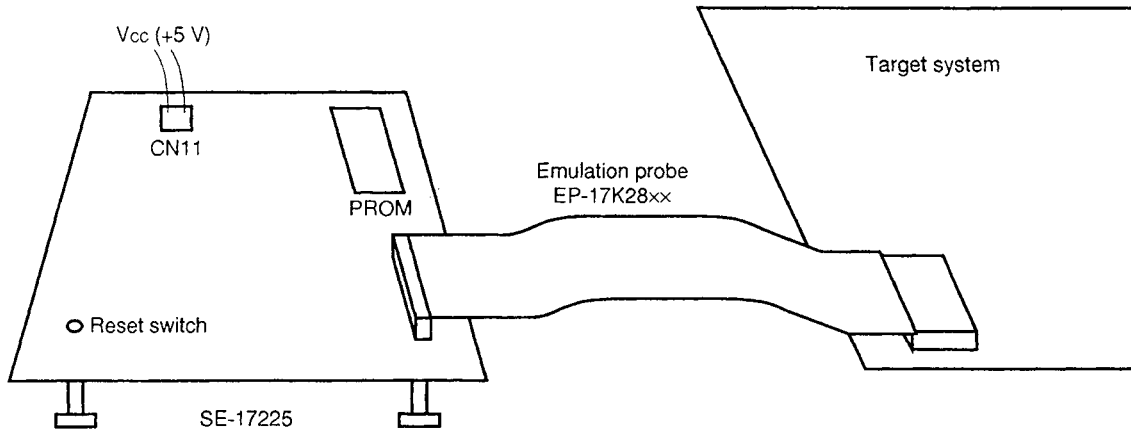

## 4.8 Monitor Pin and LED

### (1) Monitor pins

Monitor pins are provided to the SE-17225 to check the status of the following pins of the real chip. Table 4-8 lists these monitor pins, and Figure 4-17 shows the locations of the monitor pins.

**Table 4-8. Monitor Pins and Their Functions**

Monitor Pin Name	Function
CH1	For clock frequency monitoring
CH11	For crystal resonator monitoring
CH12	For user clock monitoring
GND	GND used to monitor each signal

### (2) LED1 (POWER LED)

This LED lights when the power is correctly supplied to the SE board. For details, refer to **4.6 Use When SE Board Is Connected to In-Circuit Emulator** and **4.7 Using SE Board Alone**.

### (3) LED2

This LED normally lights. It remains unlit in the high-speed mode.

Figure 4-17. Monitor Pin and LED Locations

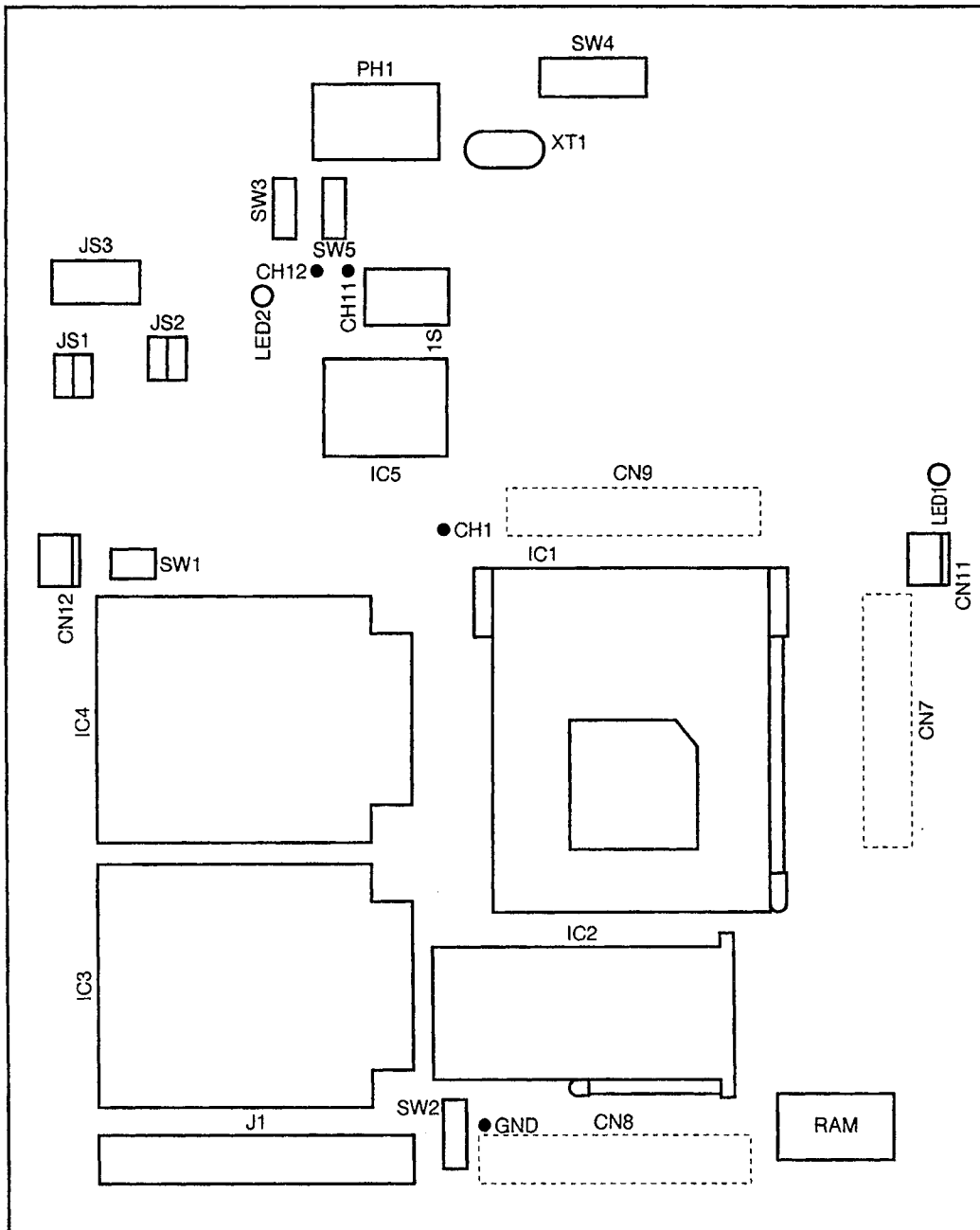

## 4.9 Setting of Jumper Switches and Slide Switches

The jumper switches and slide switches of the SE-17225 are factory-set as follows for shipment.

### (1) Oscillator

The clock oscillator select switch (SW5) is set to the "CE" side as a factory-set condition for shipment, and the oscillation frequency to be supplied to the real chip is set to 4 MHz.

To change the oscillation frequency from 4 MHz, change the setting of SW5, and the oscillator and capacitor on the component block (PH1) on the SE board (refer to **4.5 Changing Oscillation Frequency**).

### (2) Jumper switches and slide switches

The jumper switches and slide switches are set as shown in Table 4-9 as the factory default. Check the set conditions.

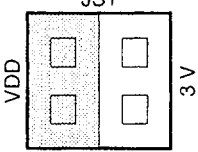
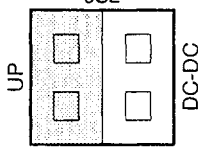
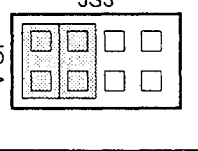
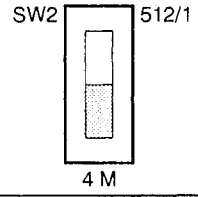
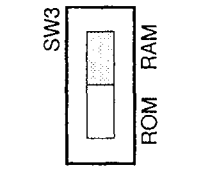
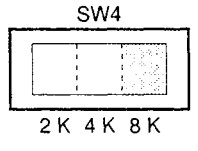
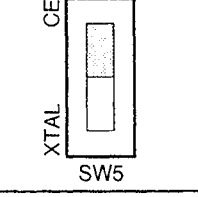
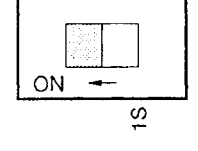

Table 4-9. Factory-Set Conditions of Jumper Switches and Slide Switches

Switch No.	Jumper Switch and Slide Switch	Set Conditions	Set Position	
JS1		Refer to 4.2 Using Level Conversion Chip ( $\mu$ PD6706GF) and 4.3 Supplying Power to SE Board.		
JS2		Connected as shown as factory-set condition.	Do not change this setting.	
JS3		Connected as shown as factory-set condition.	Do not change this setting.	
SW2		For evaluation with SE board connected to in-circuit emulator	512 /1M side	
		For evaluation with SE board used alone	$\mu$ PD27C512D	512 /1M side
			$\mu$ PD27C1001D	4 M side
SW3		For evaluation with SE board connected to in-circuit emulator	RAM side	
		For evaluation with SE board used alone	ROM side	
SW4		When $\mu$ PD17225 is mounted	Position of 2 K	
		When $\mu$ PD17226 is mounted	Position of 4 K	
		When $\mu$ PD17227 is mounted When $\mu$ PD17228 is mounted	Position of 8 K	
SW5		To operate with 4-MHz crystal resonator clock	XTAL side	
		To operate with clock of oscillator mounted to PH1	CE side	
1S		For details, refer to 4.4 Option Switch.		

[MEMO]

## CHAPTER 5 CONNECTOR PIN LIST

**Table 5-1. Connector Pins of J1**

J1 Pin No.	Pin Name (pin No. of IC)	J1 Pin No.	Pin Name (pin No. of IC)	J1 Pin No.	Pin Name (pin No. of IC)
1	GND	21	GND	41	GND
2	P0D <sub>1</sub> (28)	22	P0C <sub>0</sub> (23)	42	P0A <sub>3</sub> (18)
3	GND	23	GND	43	GND
4	P0D <sub>2</sub> (1)	24	P0E <sub>2</sub> (6)	44	X <sub>IN</sub> (11)
5	GND	25	GND	45	GND
6	P0D <sub>0</sub> (27)	26	P0B <sub>3</sub> (22)	46	P0A <sub>2</sub> (17)
7	GND	27	GND	47	GND
8	P0D <sub>3</sub> (2)	28	P0E <sub>3</sub> (7)	48	GND (12)
9	GND	29	GND	49	GND
10	P0C <sub>3</sub> (26)	30	P0B <sub>2</sub> (21)	50	P0A <sub>1</sub> (16)
11	GND	31	GND	51	GND
12	INT (3)	32	REM (8)	52	$\overline{\text{RESET}}$ (13)
13	GND	33	GND	53	GND
14	P0C <sub>2</sub> (25)	34	P0B <sub>1</sub> (20)	54	P0A <sub>0</sub> (15)
15	GND	35	GND	55	GND
16	P0E <sub>0</sub> (4)	36	V <sub>DD</sub> (9)	56	$\overline{\text{WDOUT}}$ (14)
17	GND	37	GND	57	GND
18	P0C <sub>1</sub> (24)	38	P0B <sub>0</sub> (19)	58	NC
19	GND	39	GND	59	GND
20	P0E <sub>1</sub> (5)	40	X <sub>OUT</sub> (10)	60	NC

[MEMO]

CHAPTER 6 DRAWING OF EMULATION PROBE AND CONVERSION ADAPTER

6.1 Drawing of Emulation Probe (optional)

Figure 6-1. Drawing of EP-17K28CT (unit: mm)

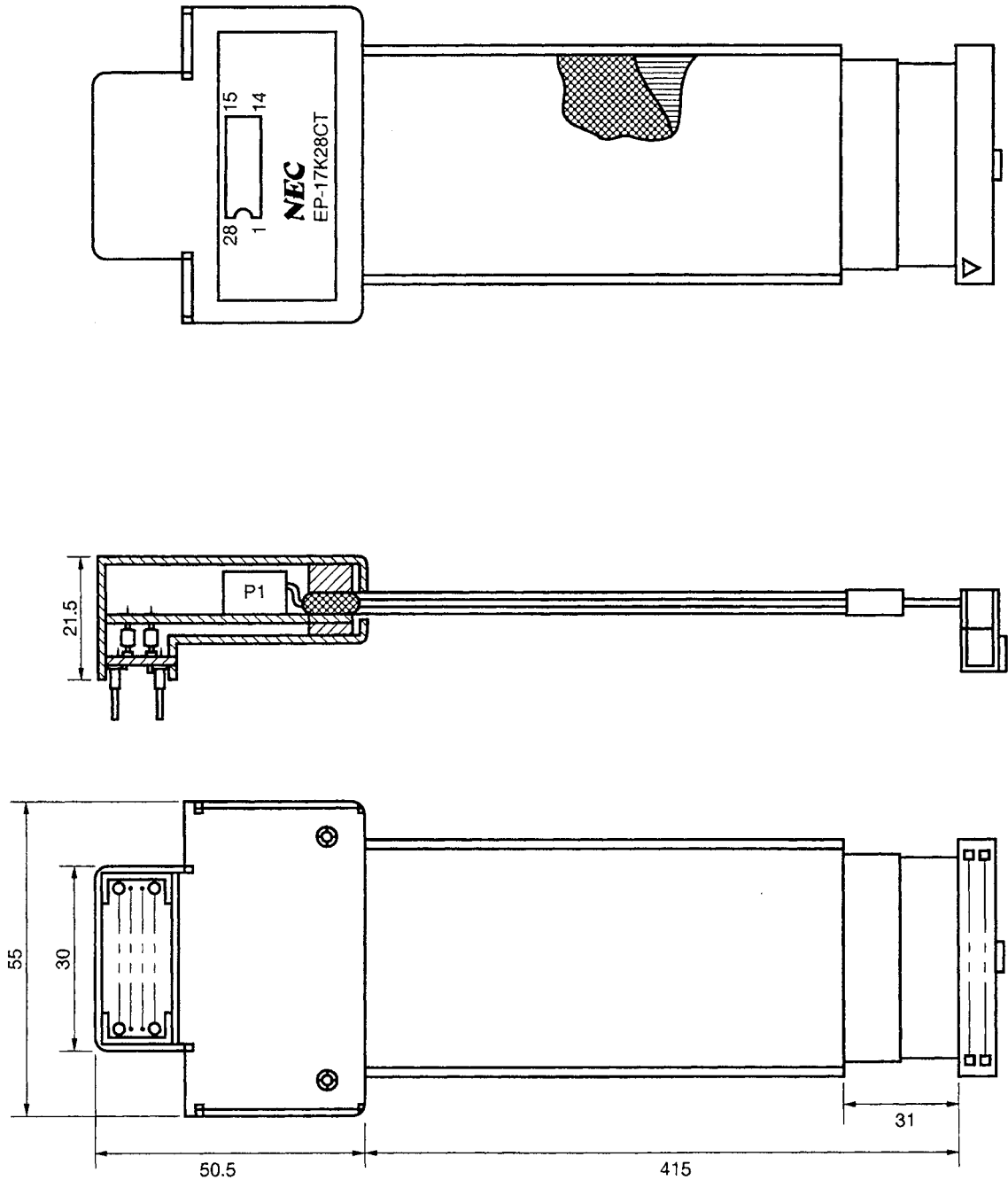

Figure 6-2. Drawing of EP-17K28GT (cable) (unit: mm)

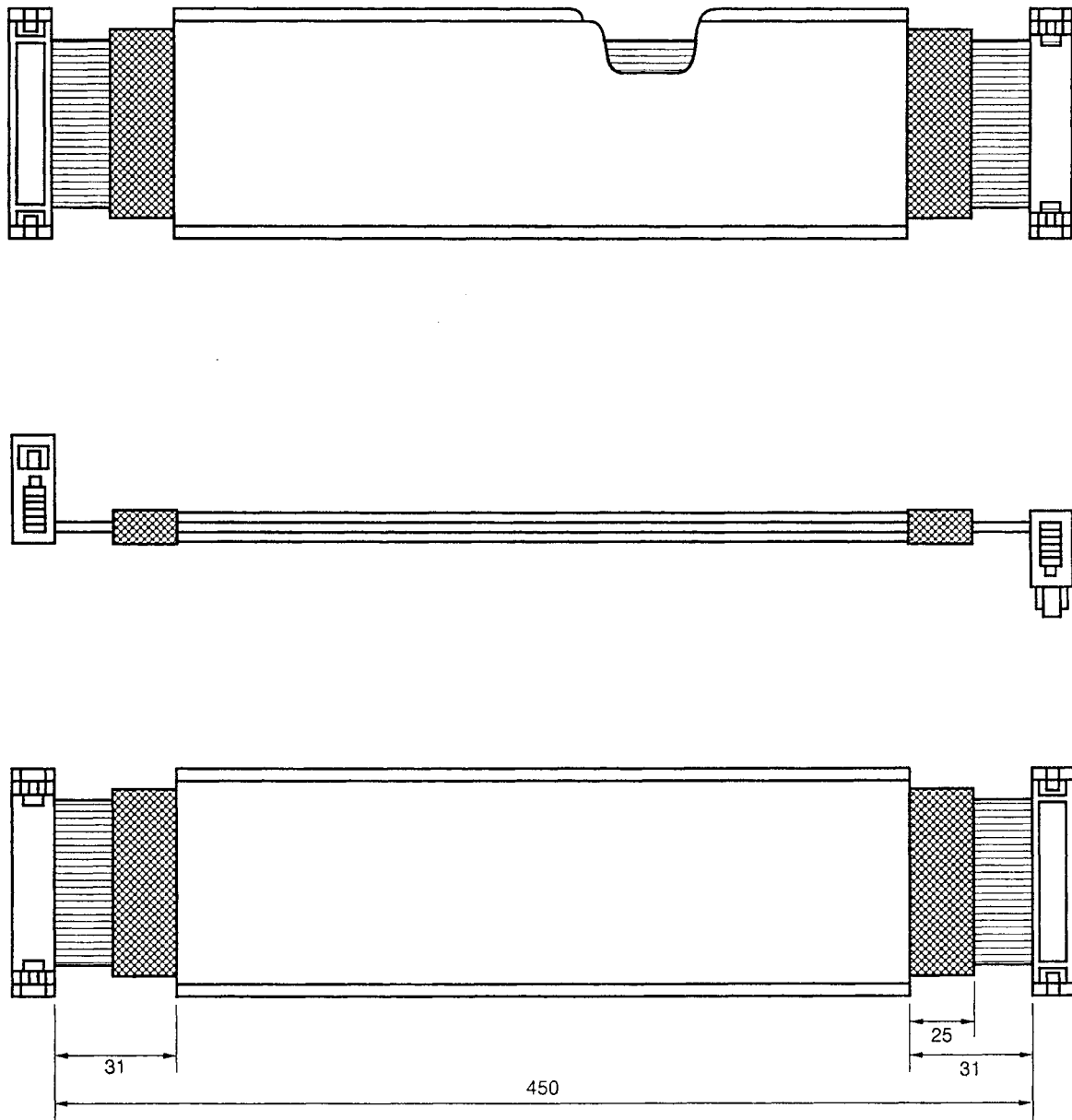
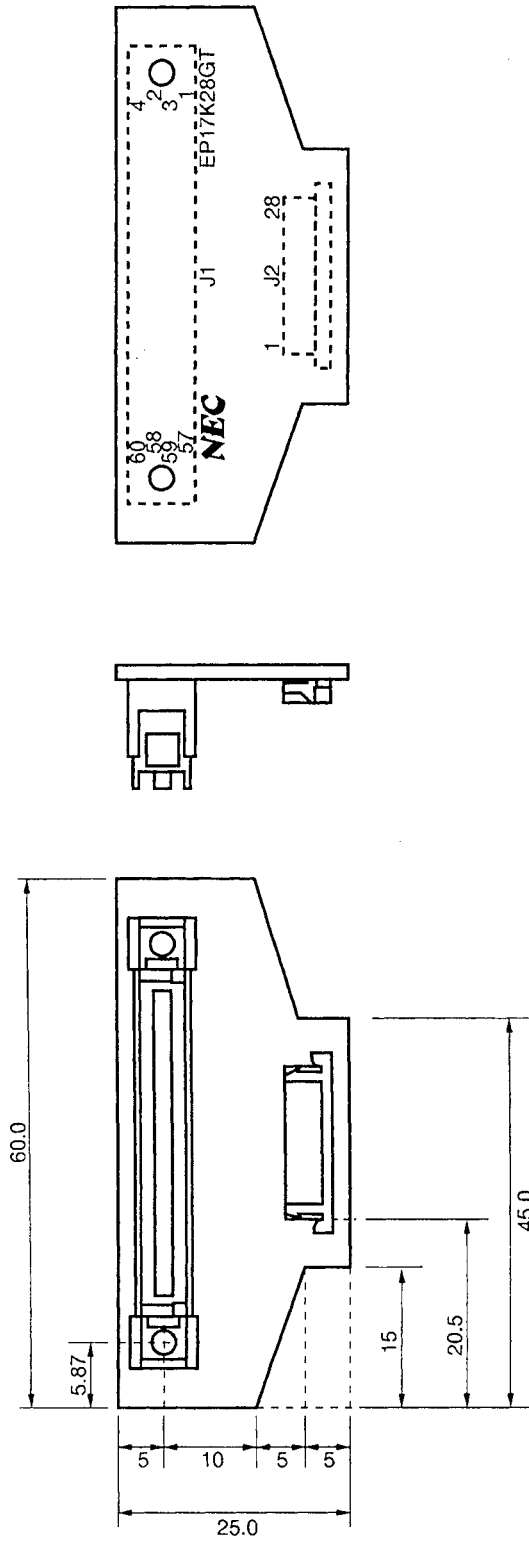

Figure 6-3. Drawing of EP-17K28GT (connector board) (unit: mm)



6.2 Drawing of Conversion Adapter (optional)

Parts number: EV-9500GT-28

Figure 6-4. Drawing of Conversion Adapter (unit: mm)

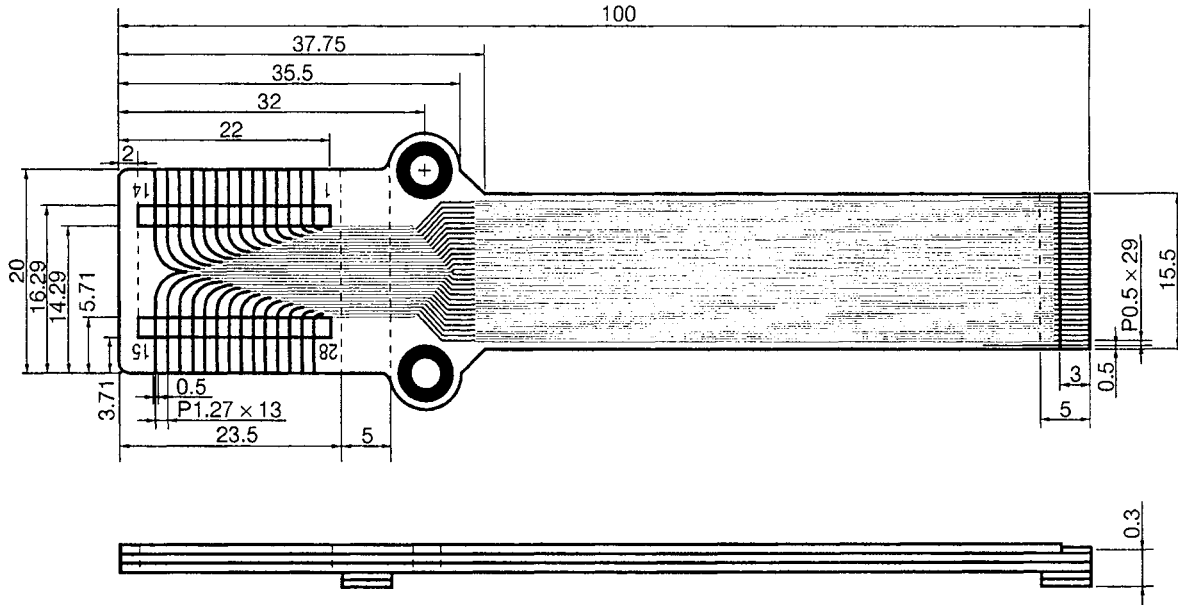



## CHAPTER 7 NOTES ON USING EMULATION PROBE (EP-17K28GT)

Connect the SE-17225 and target system with emulation probe EP-17K28GT as follows:

### (1) Connection of EP-17K28GT and SE-17225

Connect the connector J1 of the EP-17K28GT to the connector J1 on the SE-17225. A connector board and a flat cable are connected to the EP-17K28GT as the factory default (these board and cable can be disconnected).

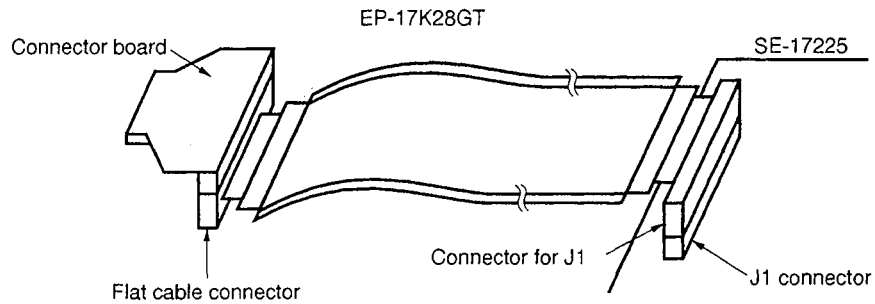

### (2) Connection of EP-17K28GT and target system

Remove the connector board from the EP-17K28GT.

Next, connect the connector board and conversion adapter (EV-9500GT-28), and solder the flexible board head of the conversion adapter to the target system.

Then connect the connector board and EP-17K28GT.

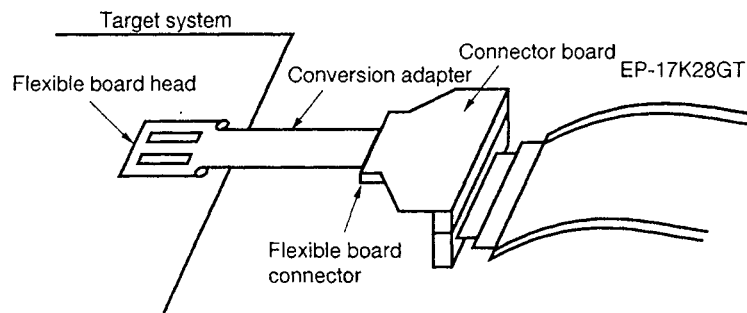

[MEMO]

## Facsimile Message

Although NEC has taken all possible steps to ensure that the documentation supplied to our customers is complete, bug free and up-to-date, we readily accept that errors may occur. Despite all the care and precautions we've taken, you may encounter problems in the documentation. Please complete this form whenever you'd like to report errors or suggest improvements to us.

From:

Name

Company

Tel.

FAX

Address

**Thank you for your kind support.**

**North America**

NEC Electronics Inc.  
Corporate Communications Dept.  
Fax: 1-800-729-9288  
1-408-588-6130

**Hong Kong, Philippines, Oceania**

NEC Electronics Hong Kong Ltd.  
Fax: +852-2886-9022/9044

**Asian Nations except Philippines**

NEC Electronics Singapore Pte. Ltd.  
Fax: +65-250-3583

**Europe**

NEC Electronics (Europe) GmbH  
Technical Documentation Dept.  
Fax: +49-211-6503-274

**Korea**

NEC Electronics Hong Kong Ltd.  
Seoul Branch  
Fax: 02-528-4411

**Japan**

NEC Semiconductor Technical Hotline  
Fax: 044-435-9608

**South America**

NEC do Brasil S.A.  
Fax: +55-11-6462-6829

**Taiwan**

NEC Electronics Taiwan Ltd.  
Fax: 02-2719-5951

I would like to report the following error/make the following suggestion:

Document title: \_\_\_\_\_

Document number: \_\_\_\_\_ Page number: \_\_\_\_\_

\_\_\_\_\_  
\_\_\_\_\_  
\_\_\_\_\_

If possible, please fax the referenced page or drawing.

Document Rating	Excellent	Good	Acceptable	Poor
Clarity	<input type="checkbox"/>	<input type="checkbox"/>	<input type="checkbox"/>	<input type="checkbox"/>
Technical Accuracy	<input type="checkbox"/>	<input type="checkbox"/>	<input type="checkbox"/>	<input type="checkbox"/>
Organization	<input type="checkbox"/>	<input type="checkbox"/>	<input type="checkbox"/>	<input type="checkbox"/>